

ODD COURSES

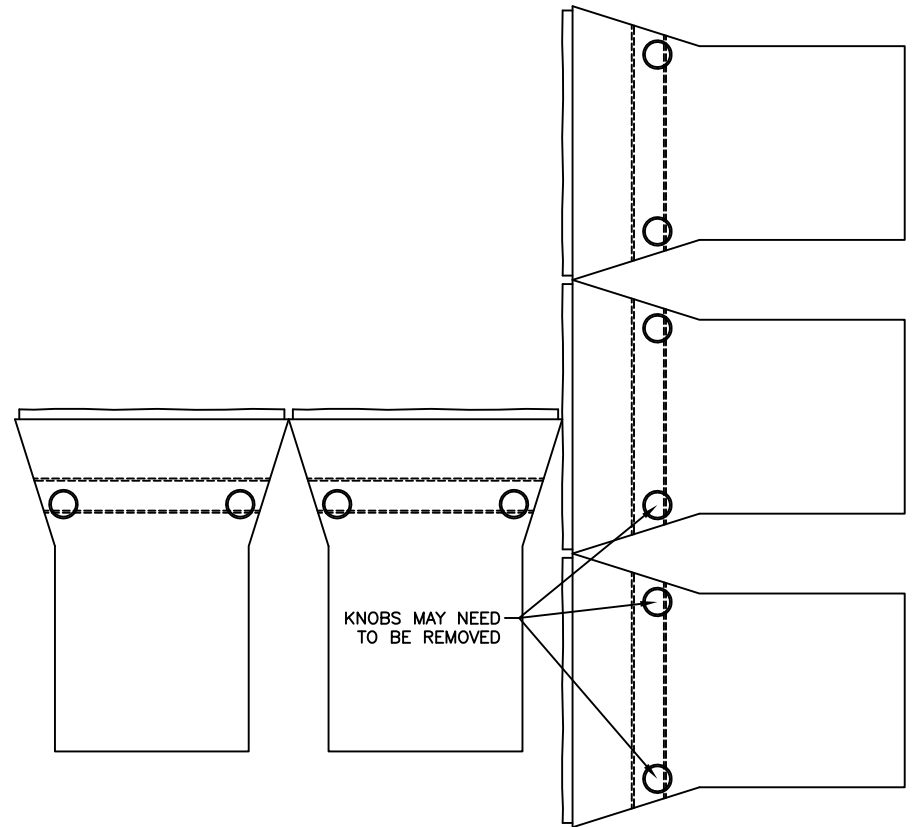

EVEN COURSES

INSIDE 90° CORNER

60 INCH UNITS

SCALE: NONE

PRELIMINARY

THIS DRAWING IS PRELIMINARY AND SHOULD BE USED FOR ESTIMATING PURPOSES ONLY. A FINAL DESIGN SHOULD BE PERFORMED BY A QUALIFIED REGISTERED ENGINEER. DETERMINATION OF THE SUITABILITY OF ANY INFORMATION OR MATERIAL FOR THE USE CONTEMPLATED, AND ITS MANNER OF USE, IS THE SOLE RESPONSIBILITY OF THE USER.



VERSA-LOK®
Retaining Wall Systems

(800)770-4525 fax(651)770-4089
6348 Hwy36 Ste1, Oakdale, MN 55128 **Solid Solutions™**

INSIDE 90° CORNER

BRONCO 18H

SCALE:	NONE
DRAWN BY:	PDL
CHECKED BY:	
DATE:	2/2017
DWG. NO.	B18H INSIDE 90° CORNER 60